

Alba Vesa Nilsson

INNOLUX

Asennusohje / Installation manual / Bruksansvisning
V.23B_ATO

1x

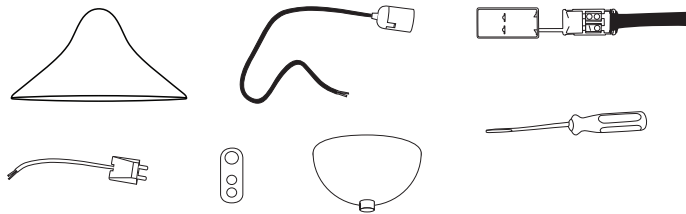

Suositteltu valonlähde / Recommended lightsource
/ Rekommenderade ljuskällan:

5 - 8W
LED
E27



HUOM: Käännä sähköt pois sähkökeskuksesta ennen asennusta.
NOTICE: Switch off the main electricity before installing.
OBS: Vänd av elektricitet från elcenter.

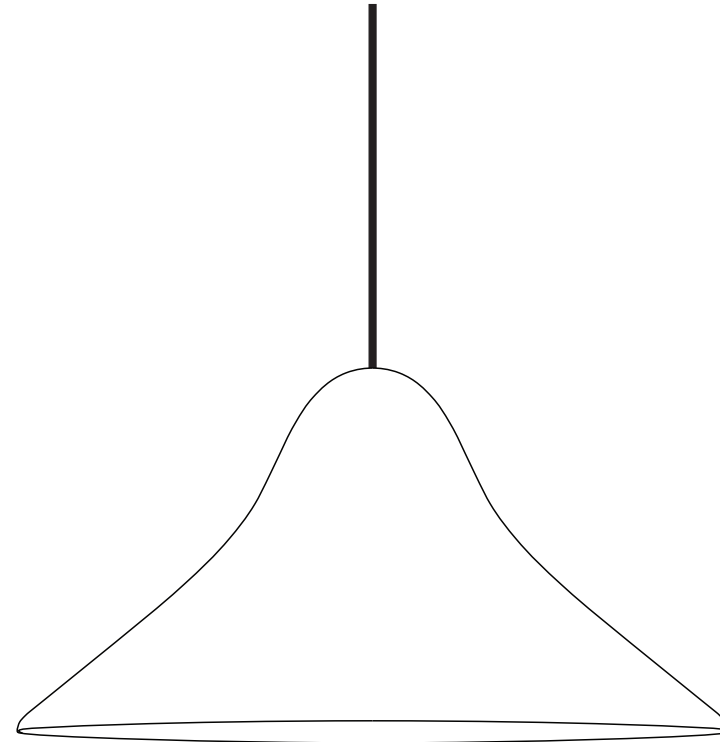

1

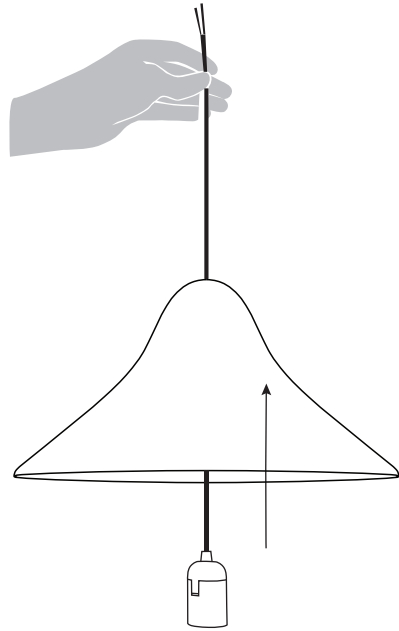

2

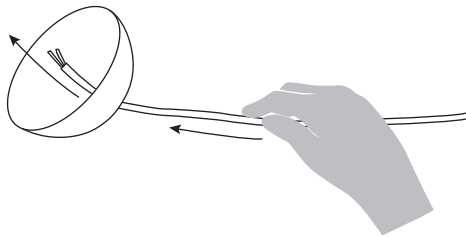

3

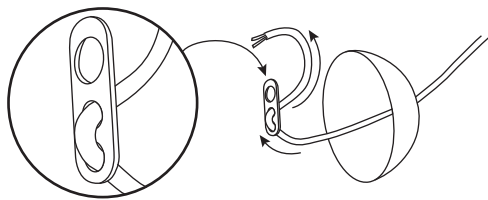

4A

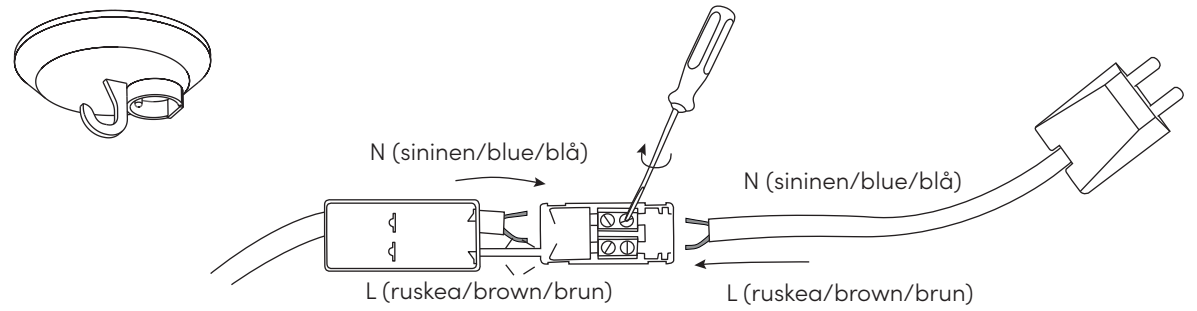

4B

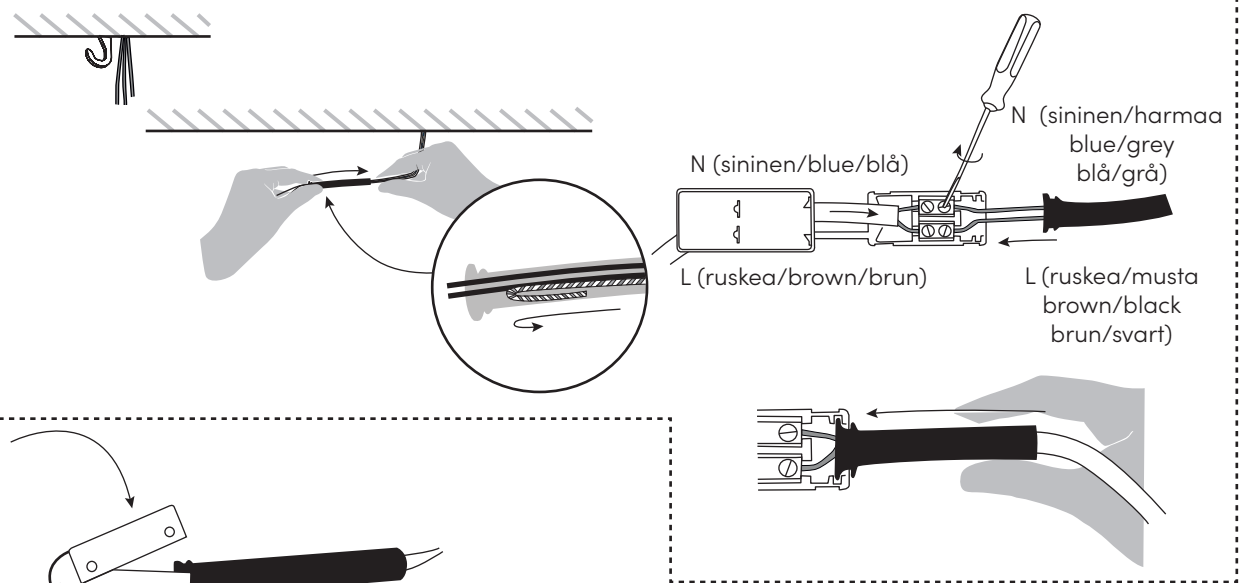

5

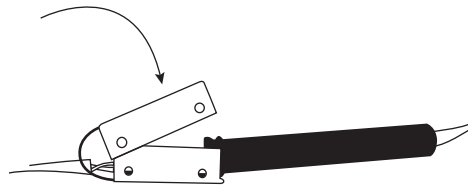

6

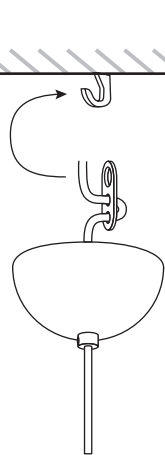

7

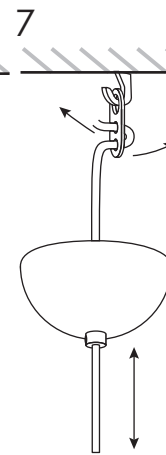

8

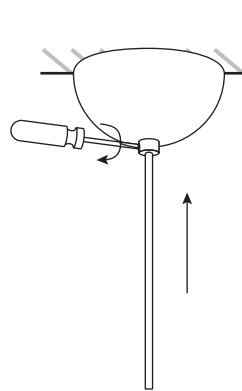

9

